



MULTIFUNCTION CABLE CERTIFIER

# TestPro (CV100)

The changing landscape of enterprise cabling demands more from the test equipment you rely on





# Multifunction Testing Solution

The award winning TestPro™ Multifunction Cable Certifier, offers an extensive suite of test function, through hot swappable test adapters.

If you're only looking for copper and fiber optic certification, TestPro offers competitively priced testing kits.

Need a bit more function to better manage smart building deployments or add a new service offering?

TestPro is available in complete smart building test kits, taking the guess work out of trying to figure out which adapter you need.

Additionally, there is only one high-performance TestPro platform, so any kit you purchase, is compatible with all adapters making it easy to add function as needs change.

## High Level Testing Support Summary



### Copper Certification

Certify Cat3 through Cat8.2, shows network compliance up to 40 Gbps Ethernet.



### Fiber Certification

Dual wavelength loss and length measurement leading to tier 1 certification for Multimode and Singlemode. Hybrid powered fiber voltage/resistance measurement. Network compliance for a variety of fiber networks including 100GBASE-LR4, 40GBASE-LR4 and Fibre Channel.



### OTDR

Multimode and Singlemode OTDR adapters provide additional troubleshooting to easily pinpoint distance to a broken fiber or other loss-inducing events which cause a failure during Optical Loss Testing. Adding OTDR testing to the Optical Loss Testing provides Tier-2 Fiber Optic Certification.



### Multi-Gigabit Link Speed

Validate cabling link speeds for 1/2.5/5/10GBASE-T. End-to-end Signal to Noise Ratio (SNR) measurement provides a quick and objective assessment of link performance under simultaneous traffic and PoE load condition.



### Single Pair Ethernet (SPE)

Support for SPE Cabling standards with testing capability up to 1800 meters.



### Power Over Ethernet (PoE)

Comprehensive test function verifies PoE configuration at PSE and reports current/wattage/voltage at PD jack. Emulates PD negotiation with PSE and supports for 802.3af/at/bt, and UPoE. Sustained load testing with external load box that can "dial-up" power.



### Wired Network Connectivity Testing

Network discovery shows all connected devices including drill down into device details. Switch detail includes slot/port/VLAN, switch name, make/model, port capabilities and MAC/IPv4/IPv6 and VLAN usage detail. Network discovery reveals connected devices with drill in capability for further investigation and troubleshooting. Troubleshooting kit includes Traceroute, ping, tone generator and more.



### Wireless Network Connectivity Testing

Discover all Access Points (APs), their SSID, RSSI (received power level) and Channel. Login to the AP to verify connectivity. Roaming signal strength handy for locating those pesky dead zone. Troubleshooting toolkit includes Traceroute, Ping and more.



# Copper Certification

TestPro is warranty approved by a long list of cable manufacturers. Check our website for more details.

TestPro's Cat 6A Autotest takes only six seconds and will save you time by getting more links tested faster and with more test detail. TestPro's default Autotest includes all certification requirements, in addition to those you see noted below. Be aware of competitive tester claims for how fast their test times are, be sure you know what is and is not included in the test time quoted as compared to TestPro. Live WireMap™ provides an immediate indication of cable connected, including a visual display of pin-out connectivity and any mis-wires, much more helpful than just a red or green light.

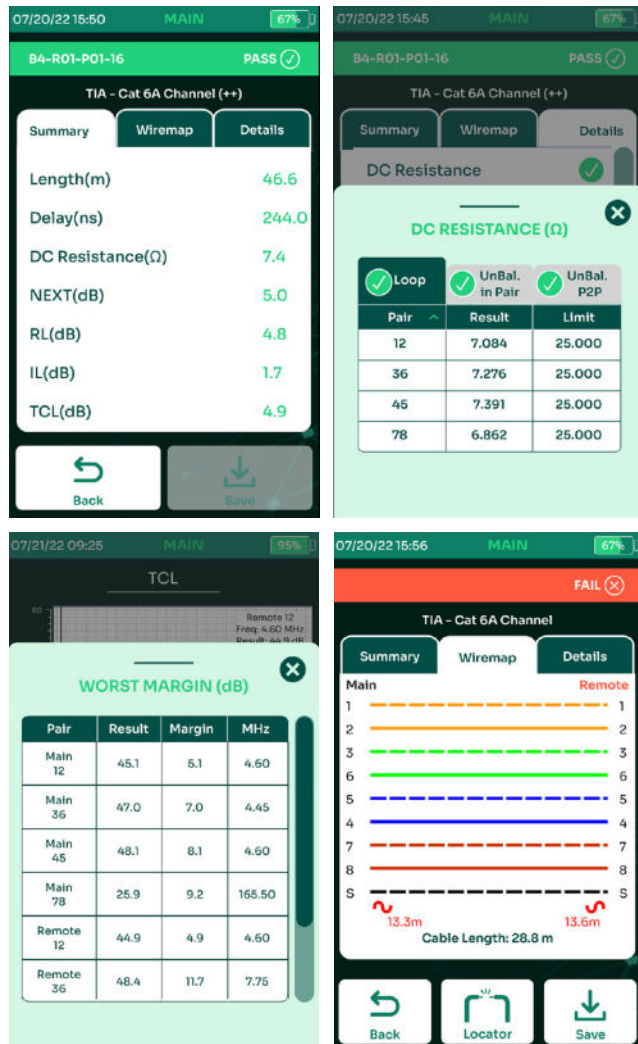

*“As part of the 6 second CAT6A++ Autotest, TestPro will perform all standard measurements in addition to extra parameters such as DC Resistance Unbalance, ELTCTL, TCL, fault location, and more for both Channel and Permanent Link.”*

TestPro supports testing and certification for network deployments up to 40 Gigabit Ethernet for Cat3 through Cat8.2 or Class I/II cabling system. The electrically centered test plug assures the Level 2G/VI accuracy required to support field testing to Cat 8 / Class I/II, and actually exceeds the 2000 MHz requirement, to offer a 3000 MHz platform. The 3000 MHz frequency range provides investment protection as standards evolve, the test platform is ready.

TestPro offers fault location for Return Loss, NEXT, and Shield aiding in problem identification. Support for MPTL, Patch Cord, Single Pair Ethernet, GG45, Tera, and Coax is available through hot swappable adapters. At the completion of the Autotest, you get a highly visible Pass or Fail indication, and test results can be automatically saved with a customizable labeling scheme.

TestPro will store over 10,000 results in memory, but when it's time to prepare printed reports, the included TestDataPro PC based software provides a way to organize and manage results and provide printed reports. If you prefer to upload as you test, TestDataPro Cloud allows you to upload test results via wired or wireless internet connection.

*Channel and Permanent Link Adapters that support Cat3 through Cat8.1 are included in the TestPro CV100-K50E, K51E, K60E, K61E, K71E Kits.*



# Single Pair Ethernet

Single Pair Ethernet / 10BASE-T1L, is the perfect solution for low bandwidth, long distances, secure powered bidirectional communications. Everyone accepts the ubiquity of Ethernet. With the advent of Single Pair Ethernet (SPE) however, reach and applications will extend even further. Single Pair Ethernet can support communication and power delivery up to 1 km. Since many IoT devices were designed for Ethernet, SPE eliminates the need for protocol conversion, additional controllers, and more complex cabling required for legacy non-Ethernet architecture.

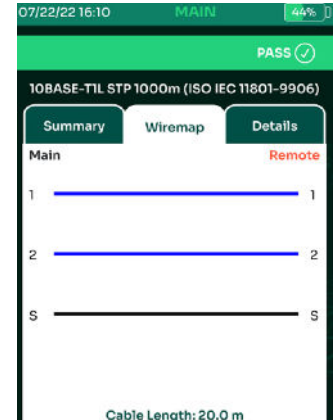
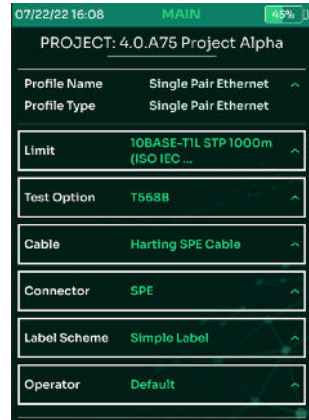

**A-002** Pass

Test Time : 5/12/2021 2:07:54 PM  
 Project : SPE1  
 Profile : Single Pair Ethernet  
 Operator : Default  
 Cable Type / NVP : CUSTOM 54 C6 , 68%  
 Connector : UTP SPE

Limit : 10BASE-T1L STP 1000m (ISO IEC 11801-9906)  
 Model : TestPro CV100  
 Serial Number : Main: 5200-1227, Remote: 5200-1228  
 Device Software : 3.5.R1  
 Calibration Date : Wednesday, January 13, 2021  
 Main Adapter : PROBE SPE  
 Remote Adapter : PROBE SPE

Parameter	Result	Pair	Value	Limit
Length(m)	Pass	12	6.4	3050.0
Prop Delay(ns)	Pass	12	10.0	8834.0
Delay Skew(ns)	Info	12	0.0	0.0
DC Loop Resistance(Ω)	Pass	12	0.474	47.660
Res. Unbal. wire-wire(Ω)	Info	12	0.000	0.200

**RF Parameters**

Parameter	Result	Main				Remote									
		Pair	Worst Margin (dB)	Limit (dB)	Worst Value (dB)	Pair	Worst Margin (dB)	Limit (dB)	Worst Value (dB)						
Return Loss	Pass	12	12.5	13.5	19.96	12	23.6	0.18	12	9.6	10.2	0.12	12	19.7	0.10
Insertion Loss	Pass	12	10.0	9.9	0.14	12	0.0	0.10	-	-	-	-	-	-	-

**Insertion Loss**

**Return Loss**

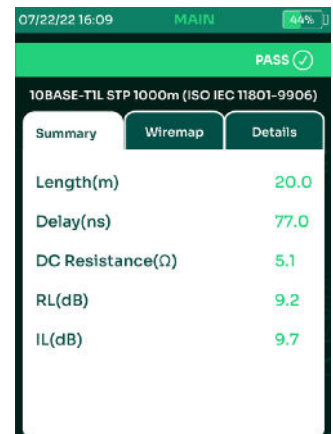
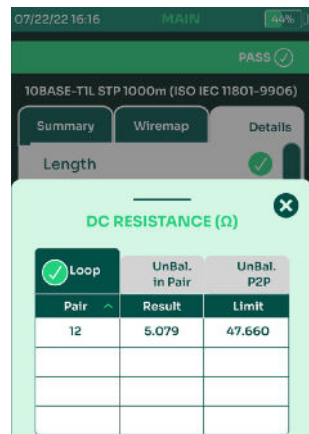

## Testing Requirements

Field testing requirements for SPE are specified in TIA 5071. AEM supports SPE with hot swappable test adapters that can be added to any TestPro. TestPro supports both IEC 63171-1 and 63171-6 connector styles and is fully compliant with TIA 5071.

TestPro is the only tester to offer SPE certification testing compliant to the TIA 568.5 standard. TestPro covers the requirements for both high-speed short reach SPE links, and long distance SPE links with the same device.



# Fiber Optic Certification

TestPro's fiber optic loss test adapters provide Tier-1 certification as well as customizable limits for both Multimode and Singlemode Fiber Optic premises cabling. Additionally, these adapters include an integrated Visual Fault Locator (VFL) to provide a quick indication of a break in the fiber.

As part of the four second Autotest, TestPro will perform the following measurements for both Singlemode and Multimode.

- Dual Ended Loss
- Length and Propagation Delay
- Loop Resistance of Copper Pair in Hybrid Powered Fiber
- Dual wavelength: 850/1300nm (MM), 1310/1550nm (SM)
- LiveWiremap™

#### Additional Test

- Single Ended Loopback Loss
- Optical Power Meter
- Printed Report Includes Test Data and Compliant Networks

For deployments where hybrid powered fiber is being used, TestPro's fiber optic loss test adapter provides not only certification of the fiber optic cable, but also provides you with the ability to measure the loop resistance of the copper pair of the hybrid powered fiber to ensure its integrity after installation. The adapters will also measure voltage at the end point to ensure voltage is present for powering remote devices/PoE extenders and is a convenience for the technician to have everything needed for testing at their fingertips.

The Multimode loss test adapters support testing of OM5 fiber in addition to earlier generation fiber standards. An Encircled Flux (EF) compliant Multimode source means no need for bulky external adapters.

With the addition of AEM's Multimode and Singlemode OTDR test adapters, which connect to the TestPro handset just like any other test adapter, users gain additional troubleshooting functionality along with Tier-2 certification capability. The OTDR gives technicians in the field the ability to easily pinpoint the location of broken fiber or other loss events causing an optical loss test to fail.

*Both SM and MM Loss Test Adapters, USB Fiber Inspection Probe are included in TestPro CV100 - K11E, K41E, K51E, K61E, K71E Kits. Both SM and MM OTDR Test Adapters, USB Fiber Inspection Probe are included in TestPro CV100 - K41E, K71E.*

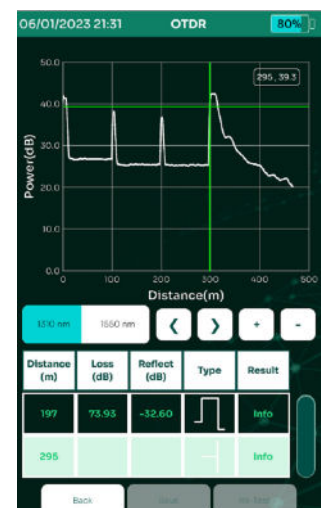
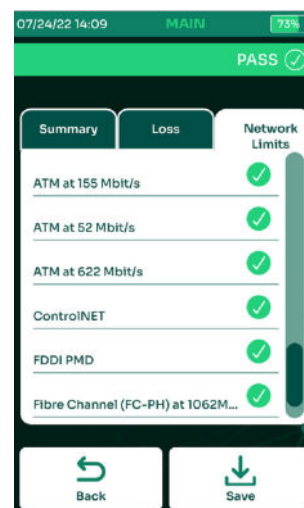
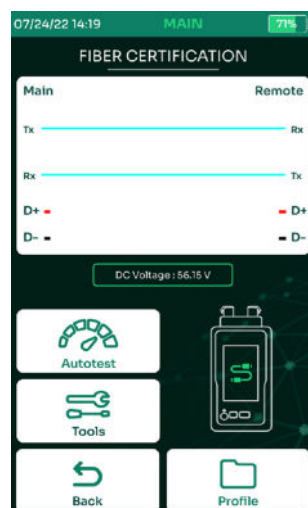
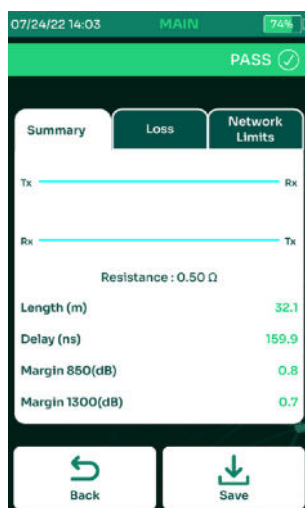



# Multi-Gigabit Link Speed Qualification

Improvements in 10Gigabit technology, price, and performance have extended its reach beyond enterprise data centers to midmarket networks. Increasing bandwidth requirements and the growth of enterprise applications are also driving broader deployments of 10 Gigabit Ethernet. TestPro's Multi-Gigabit testing provides a Pass/Fail indication as well as visibility into available headroom even down to per pair detail.

TestPro's Multi-Gigabit Signal to Noise Ratio (SNR) based test capability puts the link being tested under live network environment conditions with both traffic and PoE load, if a PSE is present. This provides a quick and meaningful assessment of link performance, available headroom, and even alien crosstalk effects on a link.



### VALIDATION TEST

- 10/100 Mbps
- 1 Gbps

### POE LOAD TEST

- 802.3 af/at/bt
- UPoE

### QoS TEST

- SNR 2.5 Gigabit
- SNR 5 Gigabit
- SNR 10 Gigabit

TestPro's Multi-Gigabit Autotest is a quick and easy one button operation to ensure that a cabling link will support the desired network rate.

Multi-Gigabit qualification testing is available in the TestPro CV100-K60E, K61E, K71E Kits. This feature may be added to any TestPro system by purchasing the MultiGig/PoE test adapter pair separately: Model AD-NET-CABLE.

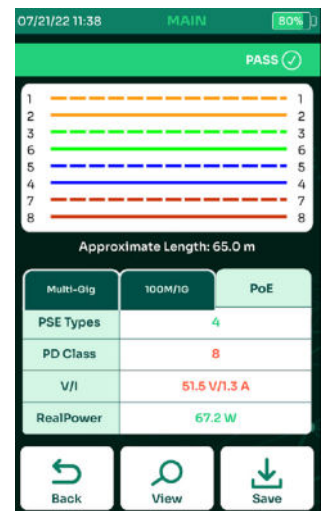
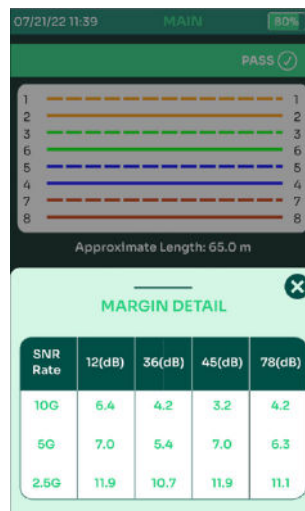



# Power Over Ethernet (PoE) Validation

TestPro excels at validating PoE with the most comprehensive test functionality available and in compliance with TIA 1152A, IEEE 802.3 af/at/bt standards, and UPoE. What sets TestPro apart is the ability to validate Real Power load at the jack where and end device will be deployed. TestPro emulates a Powered Device (PD), such as a WAP or Camera by setting it to the specific standard applicable to that device. TestPro negotiates with the Power Source Equipment (PSE) to request information about the switch and the highest level of power load from the PSE for the selected standard.

For those pesky intermittent power issues, TestPro allows for sustained loading testing over longer periods, through external loads. This allows you to monitor live for any power fluctuation that drops below the required level threshold.

TestPro can also characterize the cabling links for DC resistance unbalance parameters either as part of a standard cable certification Autotest or as a one-off quick test.

*PoE Load testing capability is included in the TestPro CV100 - K60E, K61E, K71E Kits. This feature may be added to any TestPro system by purchasing the MultiGig/PoE test adapter pair separately: Model AD-NET-CABLE.*



## POE TESTING CAPABILITIES

- Load Testing for Real Power at Jack
- Current, Wattage, Voltage
- PSE Detection
- PSE Type
- PD Class
- PoE Cable Pairs
- Sustained Power Load Monitoring

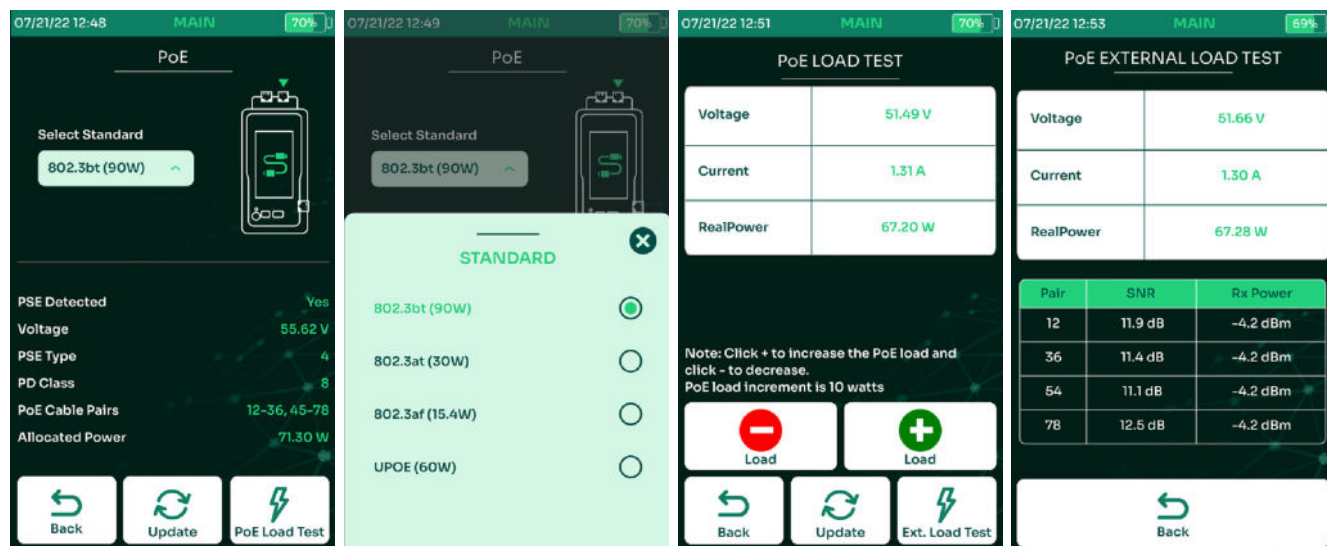



# TestDataPro Results Management



### A-004



Test Time : 8/19/2020 3:52:16 PM  
 Project : 2.9.R3  
 Profile : Default  
 Operator :  
 Cable Type / NVP : CAT 6A UTP - 68%  
 Connector : Generic Cat 6A

Limit : TIA - Cat 6A Channel  
 Model : TestPro CV100  
 Serial Number : Main: 4200-0071, Remote: 4200-0072  
 Device Software : 2.9.R3  
 Calibration Date : Friday, April 24, 2020  
 Main Adapter : PROBE CAT 6A CHANNEL  
 Remote Adapter : PROBE CAT 6A CHANNEL

Parameter	Result	Pair	Value	Limit
Length(ft)	Pass	78	159.7	328.1
Prop Delay(ns)	Pass	45	253.0	555.0
Delay Skew(ns)	Pass	45	15.0	50.0
DC Loop Resistance(Ω)	Pass	12	15.718	25.000
Res. Unbal. pair-pair(Ω)	Info	45-78	2.133	0.720
Res. Unbal. wire-wire(Ω)	Info	12	11.679	0.308

### RF Parameters

Parameter	Result	Main				Remote									
		Pair	Worst Margin (dB)	Limit (dB)	Worst Value (dB)	Pair	Worst Margin (dB)	Limit (dB)	Worst Value (dB)						
Return Loss	Pass	12	1.7	19.0	8.80	12	17.4	458.00	12	0.9	18.8	10.75	12	13.1	500.00
Insertion Loss	Pass	12	1.4	3.1	2.05	45	23.7	500.00							
NEXT	Pass	36-78	2.2	32.6	266.00	36-78	31.4	480.00	36-78	1.8	29.6	373.00	12-36	30.9	470.00
PSNEXT	Pass	36	4.0	29.7	267.00	36	29.3	480.00	36	2.4	28.8	367.00	36	28.5	475.00
ACRF	Pass	12-45	3.7	10.3	444.00	12-45	14.0	444.00	45-12	4.0	10.3	444.00	45-12	14.3	444.00
PSACRF	Pass	12	6.5	60.3	1.00	45	14.0	444.00	12	6.7	7.3	444.00	12	14.0	444.00
TCL	Info	12	-9.0	40.0	2.05	78	20.1	288.00	12	-9.2	40.0	2.20	12	17.6	433.00
TCIL	Info	45	-3.9	30.0	1.00	45	26.1	1.00	45	-0.5	30.0	1.00	45	22.6	29.95

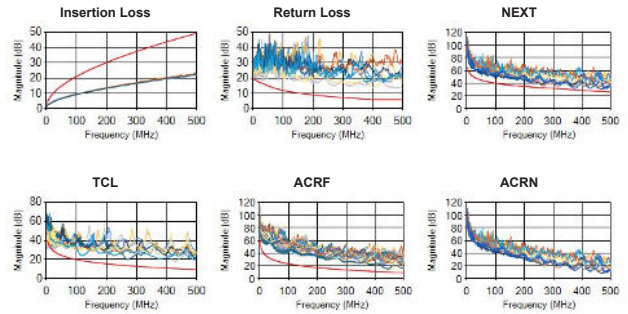

### TESTDATAPRO PC BASED

- Allows you to define projects and categorize test results into logical groupings
- Provides multiple reporting formats and options such as a single summary report or full reporting
- Allows software-based re-certification if original test was done with wrong test standard selected

### TESTDATAPRO CLOUD

- Allows immediate offload of test results to database via wired or wireless connection
- Allows visual of pass/fail results
- Allows printing of single .pdf reports

TestDataPro supports both PC and cloud-based options, and is included with all models of TestPro. Printed test reports for copper and fiber optic include a listed of compliant network support based on the performance of the cable tested.

Printed reports are provided for Copper & Fiber certification, Wired/Wireless Network Discovery Autotest as well as the combined Multi-Gigabit/PoE Autotest.

The Network Discovery and Multi-Gigabit/PoE Autotests provide a path to a new service offering you can provide to increase your revenue potential.



# Wired & Wireless Connectivity Testing

Useful for moves/adds/changes as well as general troubleshooting, TestPro will connect to a live network through the AD-NET-CABLE adapter, or wireless using the optional Edimax Wi-Fi USB adapter.

## WIRED CONNECTIVITY TESTING

- Auto-discovery reports connected devices and details
- See latency and delay with Ping and Traceroute
- Understand in-depth connected switch detail including slot/port/VLAN
- See graphical breakdown of frame count by VLAN
- Quick Autotest runs a suite of tests for you and provides a complete test report

## WIRELESS CONNECTIVITY TESTING

- Auto-discovery reports visible access points including channel and signal strength
- Login to access point to verify connectivity
- Check roaming signal strength
- Traceroute and Ping troubleshooting tools
- Supports 2.4 and 5GHz

*Wired Network Connectivity Testing is available in the TestPro CV100 K60E, K61E, K71E Kits. This adapter is also sold separately: Model AD-NET-CABLE.*

*Wireless Network Connectivity testing is available in all models of TestPro CV100 via the optional Edimax EW-7822ULC Dual Band MuMimo Wi-Fi USB adapter. These adapters are region specific and can be purchased on Amazon or any preferred retailer.*

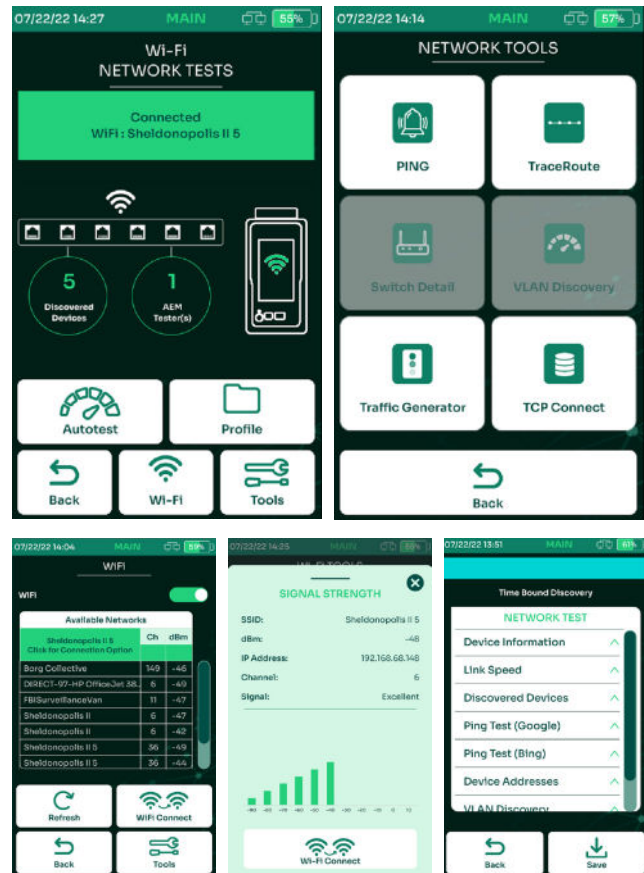

A handy savable Autotest function gives you the option to let the tester do all the work for you and automatically runs tests for:

- Device Information
- LAN Speed
- Network Map
- The Ping tests in the Autotest are not user-defined, they are fixed. Manual ping tests may be configured for different URLs/IP addresses, but not the autotest.
- Discovered Devices
- VLAN Discovery
- Switch Detail



# TestPro Platform Overview

### Exceeds Cat 8 / Class II

3000MHz/3GHz platforms exceeds current standard giving you investment protection assurance for future requirements.

### Hot Swappable Test Adapters

A variety of test adapters are available for TestPro. The most commonly used adapters are included in purpose-built kits, optional adapters allow extension of platform use.

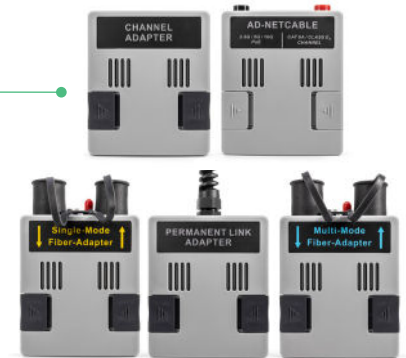

### Impact Protection

Dense rubber housing protects test equipment and display from drops. 2 Year standard warranty protects your investment. Warranty extends to 5 Years upon product reg..

### Touchscreen

Impact resistant touchscreen.

### Built-in Kickstand

Allows for ease of use when test equipment is used in a set position.

### Live Wiremap

The moment the remote unit is connected, TestPro gives an audible sound and shows wiremap and continuity for both copper and fiber optic .

### Intuitive UI

Available test function automatically adjusts when hot swappable test adapters are swapped.

### Hot Keys

Quick access buttons for Autotest Initiation and Return to Home Screen.



### CONNECTIVITY OPTIONS

Micro USB allows direct connect with PC.

USB A supports Edimax, Wi-Fi adapter and Fiber Inspection Scope as well as USB flash drive for firmware updates and test results export.

RJ-45 Ethernet port supports 10/100/1000 BASE-T testing with no test adapter needed.

# TestPro Platform Flexibility

AEM dual handset product kits contain two full function test platforms, that can each be configured as a Main or a Remote. This means, that both handsets can be independently deployed, giving you double the test equipment during end device implementation phase for wired and wireless network connectivity troubleshooting.

- When certifying copper and/or fiber optic, technicians at both ends can see full test results, aiding in problem identification and remediation.
- Test can be initiated from either end, cutting down on the time it takes to run back and forth in half, when only one technician is on the job.
- Need to throw manpower at the job to get it done fast? If you have two or more TestPro product kits, configure one platform as the Main, and all others as Remotes. Technicians out in the office area can leapfrog each other, while one technicians stays at the MDF simply moving from port to port and connecting with each remote as it sees them through live Wiremap, and then can initiate the autotest.
- During implementation phase and troubleshooting switch connectivity, link speed and PoE load, test platforms can be independently deployed, giving you double the test equipment to get the job done fast.
- Troubleshooting Wi-Fi issues, both units can be independently deployed.

Copper/Fiber Certification - Autotest can be initiated from both ends or automatically upon connection

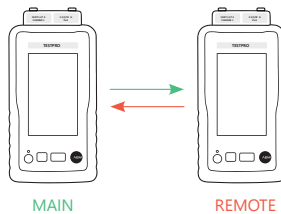

One Main to Many Remotes / Copper Cert - Autotest can be initiated from both ends or Automatically upon connection

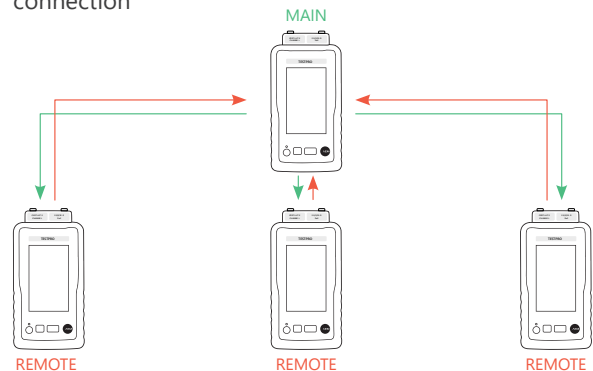

Etc. - Unlimited number of Remotes

Independently deploy each handset to become stand-alone testers for the following:

- Fiber Loopback
- PoE Load Testing
- SNR based Multi-Gig Link Speed Testing (2.5,5,10GigE)
- Wired Network Connectivity (Discovery/Switch Detail, Troubleshooting Toolkit)
- Wireless Network Connectivity (SSID Discovery/ Roaming Signal Strength, Troubleshooting Toolkit)

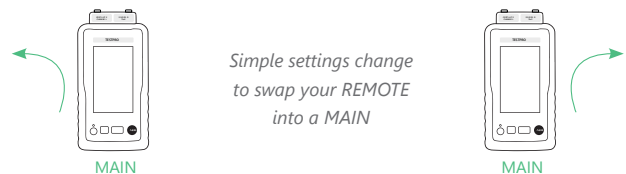

Simple settings change to swap your REMOTE into a MAIN



## Adapters & Accessories

PART NUMBER	DESCRIPTION	UOM
AD-SM-K01E	SM FIBER TEST KIT (ENHANCED) FOR TESTPRO	SET
AD-MM-K01E	MM FIBER TEST KIT (ENHANCED) FOR TESTPRO	SET
MM-ST-K01	TESTPRO ST CONNECTOR INTERFACE KIT-MM	SET
MM-SC-K01	TESTPRO SC CONNECTOR INTERFACE KIT-MM	SET
MM-FC-K01	TESTPRO FC CONNECTOR INTERFACE KIT -MM	SET
SM-ST-K01	TESTPRO ST CONNECTOR INTERFACE KIT-SM	SET
SM-SC-K01	TESTPRO SC CONNECTOR INTERFACE KIT -SM	SET
SM-FC-K01	TESTPRO FC CONNECTOR INTERFACE KIT-SM	SET
MM-LC-CORD-K01	LC REFERENCE CORD KIT FOR TESTPRO -MM	SET
SM-LC-CORD-K01	LC REFERENCE CORD KIT FOR TESTPRO -SM	SET
PROBE-FIBER-INSP	FIBER INSPECTION PROBE	EA
CABLE ASSY-HYBRID2	COPPER JUMPER FOR HYBRID POWERED FIBER	SET
AD-OTDR-SM	SINGLEMODE OTDR ADAPTER	EA
AD-OTDR-MM	MULTIMODE OTDR ADAPTER	EA
SM-LC-LC-CORD-150M	LC-LC LAUNCH CORD, 150M SINGLEMODE	EA
SM-SC-LC-CORD-150M	SC-LC LAUNCH CORD, 150M SINGLEMODE	EA
SM-SC-SC-CORD-150M	SC-SC LAUNCH CORD, 150M SINGLEMODE	EA
MM-LC-LC-CORD-150M	LC-LC LAUNCH CORD, 150M MULTIMODE	EA
MM-SC-LC-CORD-150M	SC-LC LAUNCH CORD, 150M MULTIMODE	EA
MM-SC-SC-CORD-150M	SC-SC LAUNCH CORD, 150M MULTIMODE	EA
AD-NET-CABLE	MULTIGIG AND POE ADAPTER PAIR	SET

PART NUMBER	DESCRIPTION	UOM
AD-BAREWIRE	BAREWIRE ADAPTER PAIR	SET
AD-CAT8.1-CH	CAT8.1 CHANNEL ADAPTER PAIR	SET
AD-CAT8.1-PLE	CAT8.1 PERMANENT LINK ADAPTER PAIR, ENH	SET
AD-COAX-KIT	75OHM COAX ADAPTER KIT	SET
AD-M12-D	M12 D-CODED ADAPTER PAIR	SET
AD-M12-X	M12 X-CODED ADAPTER PAIR	SET
AD-5E-PCORD	CAT-5E PATCH-CORD TEST ADAPTER PAIR	SET
AD-6-PCORD	CAT-6 PATCH-CORD TEST ADAPTER PAIR	SET
AD-6A-PCORD	CAT-6A PATCH-CORD TEST ADAPTER PAIR	SET
AD-5E-PCORD-SINGLE	CAT-5E PATCH-CORD TEST ADAPTER SINGLE	EA
AD-6-PCORD-SINGLE	CAT-6 PATCH-CORD TEST ADAPTER SINGLE	EA
AD-6A-PCORD-SINGLE	CAT-6A PATCH-CORD TEST ADAPTER SINGLE	EA
AD-8.2-TERACH	CAT8.2 TERA CHANNEL ADAPTER PAIR	SET
AD-8.2-TERAPL	CAT8.2 TERA PERM LINK ADAPTER PAIR	SET
AD-8.2-GG45CH	CAT8.2 GG45 CHANNEL ADAPTER PAIR	SET
AD-8.2-GG45PL	CAT8.2 GG45 PERM LINK ADAPTER PAIR	SET
AD-SPE-IEC 63171-1	SINGLE PAIR ETHERNET ADAPTER IEC 63171-1	SET
AD-SPE-IEC 63171-6	SINGLE PAIR ETHERNET ADAPTER IEC 63171-6	SET
ACC-HARD-CASE	HARD CARRY CASE FOR TESTPRO	EA
ACC-SOFT-CASE-SMALL	SOFT CARRY CASE FOR TESTPRO	EA
ACC-POWER-AD	AC POWER ADAPTER FOR TESTPRO	EA



TestPro Platform (All Versions)

<b>Measurement Time</b>	CAT6A auto-test (including TCL and resistance unbalance tests): 6 sec
	CAT 8 Class II auto-test: 30 sec
<b>Wiremap</b>	All possible wire connection situations identified, as long as two wires are connected end-to-end on any pins
<b>DC Resistance</b>	Range: 0 to 100 $\Omega$
	Loop resistance, pair-to-pair resistance unbalance measurement meets TIA 1152A specs
<b>Tone Generator</b>	730Hz and 1440 Hz
<b>Dual-Ended RF Measurements IL, RL, NEXT, ACR-F, TCL</b>	All mandatory and optional RF measurements as per TIA and ISO/ IEC standards
	Single-pair link testing license with supported length for dual ended testing greater than 1,000 m
<b>Length (Propagation Delay) Measurement</b>	Dual ended test: 0 – 600m with 0.1m resolution
	(0 – 6,000 nsec with 1 nsec resolution)
	Delay skew measurement with 1 nsec resolution
<b>Supportable Cabling</b>	4-pair twisted pair cable
	1-pair twisted pair cable
	Coax cable
	Optical cables (SM/MM pair)
<b>TDR-RL</b>	0-100 m (resolution: 1 m)
	Distance-to-fault
<b>TDR-NEXT</b>	0-100 m (resolution: 1 m)
<b>Impedance</b>	0-1000 $\Omega$
	0.1 $\Omega$ resolution in 90-110 $\Omega$ range

# Technical Specifications

## Test Standards Compliance & Conformity

<b>Copper Certification</b>	ANSI/TIA-568.2-D, ISO 11801 ANSI/TIA-1152-A (Levels IIIe and 2G), IEC 61935-1 Ed. 4 (Levels IIIe and V) and IEC 61935-1 Ed. 5 Draft 46/595/CD (Levels VI Class I and Class II)
<b>Fiber Optic Certification</b>	TIA-568.3-E and ISO/IEC 14763-3 Ed 2.1
<b>Single Pair Ethernet</b>	SPE Cabling Standards: TIA 568.5 (in draft), ISO/IEC TR 11801-9906-2020. SPE Field Test standards: TIA-5071 (in draft), IEC-61395-4 (in draft). IEEE Single Pair Ethernet Application standards supported: 1000BASE-T1, IEEE 802.3bp; 100BASE-T1, IEEE 802.3bw; 10BASE-T1, IEEE 802.3cg.
<b>Power Over Ethernet</b>	IEEE 802.3 af/at/bt, UPoE
<b>Multi-Gigabit Link Speed Testing</b>	IEEE 802.3 up to 10GBASE-T
<b>Wired Network Connectivity Testing</b>	CDP, LLDP
<b>Wireless Network Connectivity Testing</b>	IEEE 802.11N & IEEE 802.11AC maximum wireless speed up to 300Mbps on 2.4GHz band or up to 866Mbps on 5GHz band

## TestPro Platform (All Versions)

Each platform in a kit comes with a Certificate of Calibration traceable to NIST.

<b>Size</b>	200mm X 105mm X 50mm (7.87in X 4.13in X 1.97in)
<b>Display</b>	5" TFT color touch screen, resolution 800 x 480 pixels
<b>Battery</b>	Li-Ion, 3.7V / 13,200 mAh, 9 hr battery life typical
<b>Power Adapter</b>	5V, 3A (supplied), 5-12V (supported), 2.1mm DC jack
<b>Platform Operating System</b>	Linux
<b>USB Interfaces</b>	USB A for flash drive storage, MicroUSB for connecting to PC
<b>RJ-45 Side Port</b>	10/100/1G network connectivity test port
<b>Test Adapter To Platform Interface</b>	High-frequency connector rated for 5000 insertion cycles, Hot-swappable
<b>Measurement Engine</b>	9-channel dual-ended mixed-mode RF and DC measurement engine. Industry's highest performance patent-pending measurement architecture for data cable testing.
<b>Frequency Range</b>	0.1 – 3,000 MHz



Power Over Ethernet (K60E, K61E, K71E)

<b>Features/Test Function</b>	PoE source type detection
	Load test up to 90W
	Identification of PoE pairs
	Substained load monitor

Multi-Gigabit Ethernet (K60E, K61E, K71E)

<b>Autotest Parameters</b>	Signal to Noise Ratio at each speed across each pair
	Cable Diagnostics
	PoE Detection
<b>Network Testing</b>	Ethernet network discovery
	Switch Detail (Port, VLAN, Capabilities)
	Traceroute
	Traffic generator/monitor
	Ping
	TCP Connect
	Wi-Fi : Identify SSID's and measure RSSI

Fiber Optic - Common to both MM and SM (K11E, K41E, K51E, K61E, K71E)

<b>Test Interface</b>	Supplied Test Interface: interchangeable FC on Tx port and interchangeable LC on Rx port. FC-LC (Tx) and LC-LC (Rx) Test Reference Cords included with all adapter kits (AD-MM-K01E, AD-SM-K01E). All TestPro Kits with fiber option include above plus SC interface adapters for Tx and Rx ports, FC-SC (Tx) and SC-SC (Tx and Rx) Test Reference Cords.
<b>VFL Light Source</b>	Wavelength 650nm
<b>Volt-Ohm Meter Measurement Range, Hybrid Powered Fiber</b>	0-60V DC
	0-100 Ω

### Fiber Optic - Multimode and Singlemode Adapter - Specific Information

	<b>Multimode AD-MM-01E Adapter</b>	<b>Singlemode AD-SM-01E Adapter</b>
<b>Wavelengths</b>	850nm, 1300nm	1310nm, 1550nm
<b>Light Source</b>	LED	Fabry-Perot Laser
<b>Transmit Power</b>	-20dBm typical	-2dBm typical
<b>Encircled Flux</b>	Compliant to IEC-61280-1-4 and TIA526-14-C-2015 as per supplier data sheet	Not applicable
<b>Length Measurement</b>	Range: up to 2km (subject to maximum of 10dB link loss)	Range: up to 20km (subject to maximum 20dB link loss)
	Length measurement resolutions: 0.1m	Length measurement resolution: 0.1m
<b>Dual Ended Loss</b>	Dual ended loss measurement: 0 to -10dB	Dual ended loss measurement: 0 to -20dB

### Fiber Optic - OTDR

<b>Parameter</b>	<b>Multimode</b>	<b>Singlemode</b>
<b>Wavelength Range</b>	850nm +/- 10nm	1310 +/- 25 nm
	1300nm +35/-15nm	1550 +/- 30 nm
<b>Compatible Fiber type</b>	50/125 µm, 62.5/125 µm for multimode	Single mode
<b>Event Dead Zone</b>	2.5m typical for 850 nm, 4.5m typical for 1300 nm	0.6m typical for 1310 nm, 0.6m typical for 1550nm
<b>Attenuation Dead Zone</b>	2.5m typical for 850 nm, 4.5m typical for 1300 nm	3.6m typical for 1310 nm, 3.7m typical for 1550nm
<b>Dynamic Range</b>	25dB for 850nm, 27dB for 1300nm	29dB for 1310nm, 27dB for 1550nm
<b>Max Distance Range Setting</b>	40 km	130 km
<b>Distance Measurement Range</b>	9km for 850nm, 35km for 1300nm	80km for 1310nm, 130km for 1550nm
<b>Reflectance Range</b>	-14 dB to -57 dB for 850nm, -14 dB to -62 dB for 1300nm	-14 dB to -65 dB for 1310nm, -14 dB to -65 dB for 1550nm
<b>Pulse Width</b>	3, 5,10, 15,...,24995, 25000 nsec	3, 5,10, 15,...,24995, 25000 nsec

SCAN QR CODE FOR

## TestPro Product Kit Selection Guide



SCAN QR CODE FOR

## Cable Manufacturer Warranty Approval



### Technical Support

#### Live Phone Support :

Monday - Friday | 8am-5pm (Arizona,USA)

T : 480-534-1232

Toll Free : 833-572-6916

Email Monitored 24hrs

[customer-care@aem-test.com](mailto:customer-care@aem-test.com)

For more information and details specifications,  
please visit: [AEM-Test.com/TestPro](https://www.aem-test.com/TestPro)

If you need technical assistance, please visit us at:  
[AEM-Test.com/customer-care](https://www.aem-test.com/customer-care)

#### AEM International, Ltd.

8930 S Beck Ave #101

Tempe AZ 85284

T : 480-498-4820

#### AEM Singapore PTE.Ltd

52 Serangoon North Ave 4

Singapore 555853

T : +65 6483 1811